

Article number: 203160M1650B1X
 Description: E+G levelling foot
 GN 31-60-M16-50-B1-X
 Note: X With female thread, External hexagon

Measures

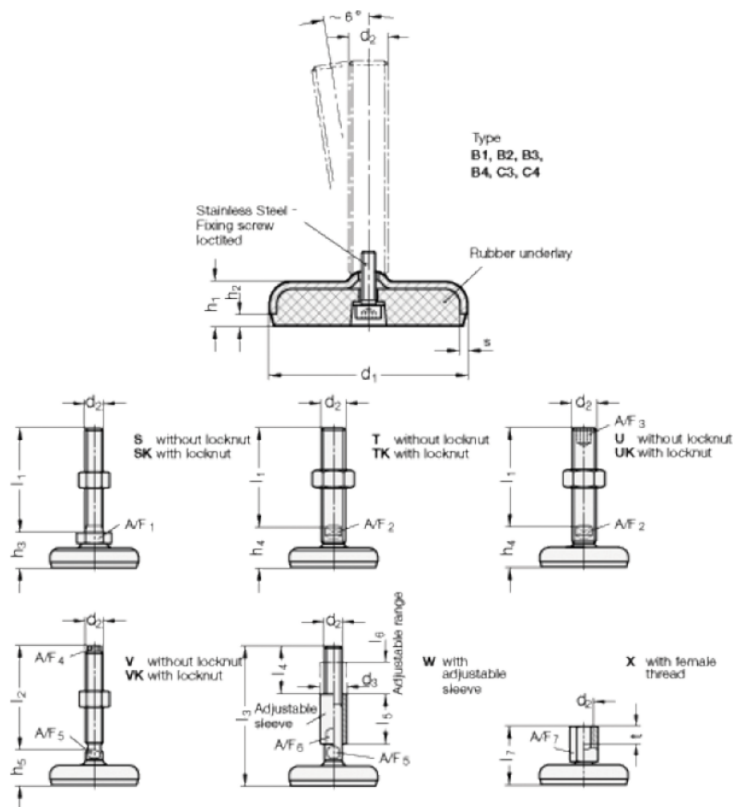

A/F7	= 22
d1	= 60
d2	= 16
h1	= 16
h2	= 4
l7 +4.0/0	= 50
s	= 3
t	= 16